



GEPON Pigtail ONU SFF Transceiver

Preliminary

SOEB3466-FUGE

SOEB3466-FUGF

FEATURES

- Single fiber bi-directional data links symmetric 1.25Gbps application
- 1310nm burst mode transmitter
- 1490nm continuous mode receiver
- 0 to 70°C operating case temperature
- 2×10 SFF package with SC/UPC pigtail connector
- Single 3.3V power supply
- LVPECL logic level data input interface
- CML logic level data output interface
- LVTTTL burst enable control
- LVTTTL receiver signal-detected indication
- TX_SD function
- Digital diagnostic monitor interface compatible with SFF-8472
- Low EMI and excellent ESD protection
- Class I laser safety standard IEC-60825 compliant
- RoHS-6 compliance

APPLICATIONS

- Gigabit Ethernet Passive Optical Networks 20Km 1:32 application or 10Km 1:64 application

STANDARDS

- Complies with SFF MSA (1998 version form-factor)
- Complies with SFF 8472
- Complies with IEEE 802.3ah
- Complies with FCC 47 CFR Part 15, Class B
- Complies with 21 CFR 1040.10 and 1040.11 except for deviations pursuant to Laser Notice No. 50, dated June 24, 2007

ABSOLUTE MAXIMUM RATING

Parameter	Symbol	Min.	Max.	Unit	Notes
Storage Ambient Temperature	T _{STG}	-40	85	°C	
Operating Case Temperature	T _c	0	70	°C	
Operating Humidity	OH	5	95	%	
Power Supply Voltage	V _{CC}	0	4	V	
Pigtail Temperature		-40	85	°C	
Soldering Temperature			260	°C	10 seconds
Receiver Damaged Threshold			+4	dBm	

RECOMMENDED OPERATING CONDITION

Parameter	Symbol	Min.	Typ.	Max.	Unit	Notes
Operating Case Temperature	T _c	0		+70	°C	
Power Supply Voltage	V _{CC}	3.135	3.3	3.465	V	
Power Supply Current	I _{CC}			300	mA	
Data Rate			1.25		Gbps	
Data Rate Drift		-100		+100	PPM	

TRANSMITTER OPTICAL CHARACTERISTICS

Parameter	Symbol	Min.	Typ.	Max.	Unit	Notes
Centre Wavelength	λ _c	1260	1310	1360	nm	
Spectral Width (RMS)				2.8	nm	
Average Output Power	P _o	0		4	dBm	EOL, Over Temperature
		1		4	dBm	BOL, Room Temperature
Burst off Average Output Power				-45	dBm	
Extinction Ratio	ER	9			dB	
Rise/Fall Time (20%~80%)	tr/tf			0.26	ns	Unfiltered PRBS2 ⁷ -1 @1.25Gbps
Turn On Time at Burst mode	T _{ON}			30	ns	
Turn Off Time at Burst mode	T _{OFF}			30	ns	
RIN ₁₅ OMA				-115	dB/Hz	
Optical Return Loss Tolerance				15	dB	
Transmitter Reflectance				-10	dB	
Transmitter and Dispersion Penalty	TDP			2	dB	Transmit on 20km SMF
Output Optical Eye		IEEE Std 802.3ah				PRBS 2 ⁷ -1 @1.25Gbps

TRANSMITTER ELECTRICAL CHARACTERISTICS

Parameter	Symbol	Min.	Typ.	Max.	Unit	Notes
Data Input Differential Swing		200		1600	mV	LVPECL input, AC coupled
Input Differential Impedance		90	100	110	Ω	
Transmitter burst control Voltage - Low		0		0.8	V	
Transmitter burst control Voltage - High		2.0		V _{CC}	V	
TX_SD indicate voltage - Low		0		0.4	V	
TX_SD indicate voltage - High		2.4		V _{CC}	V	
TX_SD turn on time at laser on	T _{TXSD_ON}			200	ns	
TX_SD turn off time at laser off	T _{TXSD_OFF}			350	ns	

RECEIVER OPTICAL CHARACTERISTICS

Parameter	Symbol	Min.	Typ.	Max.	Unit	Notes
Operating Wavelength	λ_c	1480	1490	1500	nm	
Sensitivity	SEN			-26.5	dBm	PRBS 2 ⁷ -1 @ 1.25Gbps BER \leq 10E-12, ER=9dB EOL, Over Temperature
				-27.5	dBm	PRBS 2 ⁷ -1 @ 1.25Gbps BER \leq 10E-12, ER=9dB BOL, Room Temperature
Saturation Optical Power	SAT	-3			dBm	
Signal-Detected Assert Level	SDA			-27	dBm	
Signal-Detected De-assert Level	SDD	-39			dBm	
Signal-Detected Hysteresis		0.5		6	dB	
Receiver Reflectance				-12	dB	$\lambda=1490\text{nm}$
WDM Filter isolation		38			dB	1550nm
		35			dB	1650nm

RECEIVER ELECTRICAL CHARACTERISTICS

Parameter	Symbol	Min.	Typ.	Max.	Unit	Notes
Data Output Differential Swing		300		1200	mV	CML output, AC coupled
Signal-Detected - Low		0		0.4	V	
Signal-Detected - High		2.4		V _{CC}	V	
Signal Detect Assert Time				100	us	
Signal Detect De-assert Time				100	us	

PIN DESCRIPTION			
PIN	Name	Description	Notes
1	NC	No Function Definition	
2	NC	No Function Definition	
3	V _{EER}	Receiver Signal Ground	
4	NC	No Function Definition	
5	NC	No Function Definition	
6	V _{EER}	Receiver Signal Ground	
7	V _{CCR}	Receiver Power Supply	
8	SD	Receiver Signal-Detected Indication	LVTTTL, High: signal detected; Low: loss of signal
9	RD-	Inverted Receiver Data Output	CML logic output, AC coupled
10	RD+	Non-inverted Receiver Data Output	CML logic output, AC coupled
11	V _{CCT}	Transmitter Power Supply	
12	V _{EET}	Transmitter Signal Ground	
13	TX_BM	Transmitter Burst Mode Control	LVTTTL, Transmitter on when TX_BM is high for SOEB3466-FUGE Transmitter on when TX_BM is low for SOEB3466-FUGF
14	TD+	Transmitter Non-inverted Data Input	LVPECL logic input, AC coupled
15	TD-	Transmitter Inverted Data Input	LVPECL logic input, AC coupled
16	V _{EET}	Transmitter Signal Ground	
17	SCL	Clock Line of the I2C interface	The clock line of two wire serial interface
18	SDA	Data Line of the I2C interface	The data line of two wire serial interface
19	TX_Fault	Transmitter Fault	LVTTTL, internal pull-up
20	TX_SD	Transmitter State Indication, TX_SD Assert When Transmitter On	LVTTTL, internal pull-up
	MS	Mounting Studs	Connected to chassis ground not to signal ground

PIN OUT DRAWING (TOP VIEW)

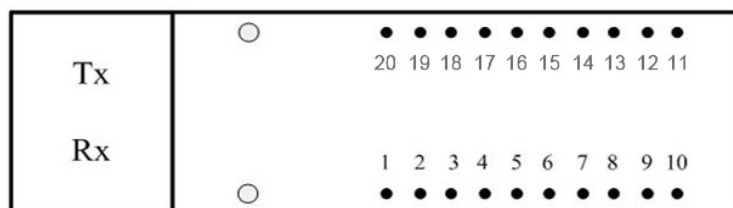
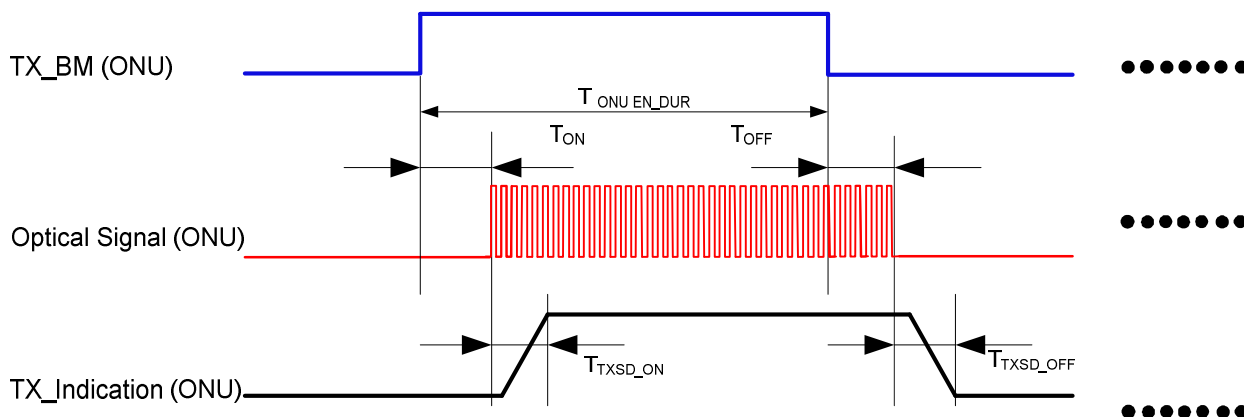

Figure 1 Pin out Drawing (Top view)

TYPICAL ONU TIMING SEQUENCE

For SOEB3466-FUGE, the TX_BM signal is high active:



For SOEB3466-FUGF, the TX_BM signal is low active:

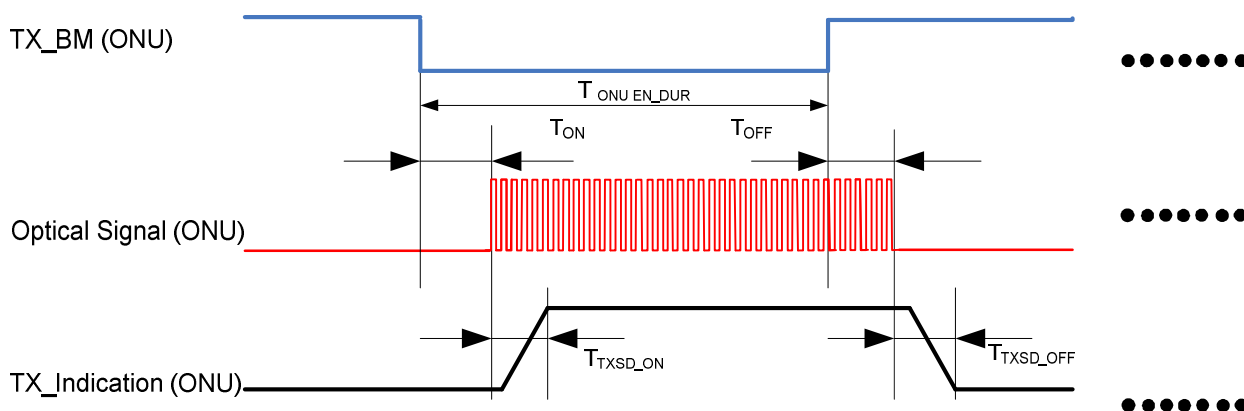

Figure 2 Typical ONU Timing Sequence

TYPICAL INTERFACE CIRCUIT

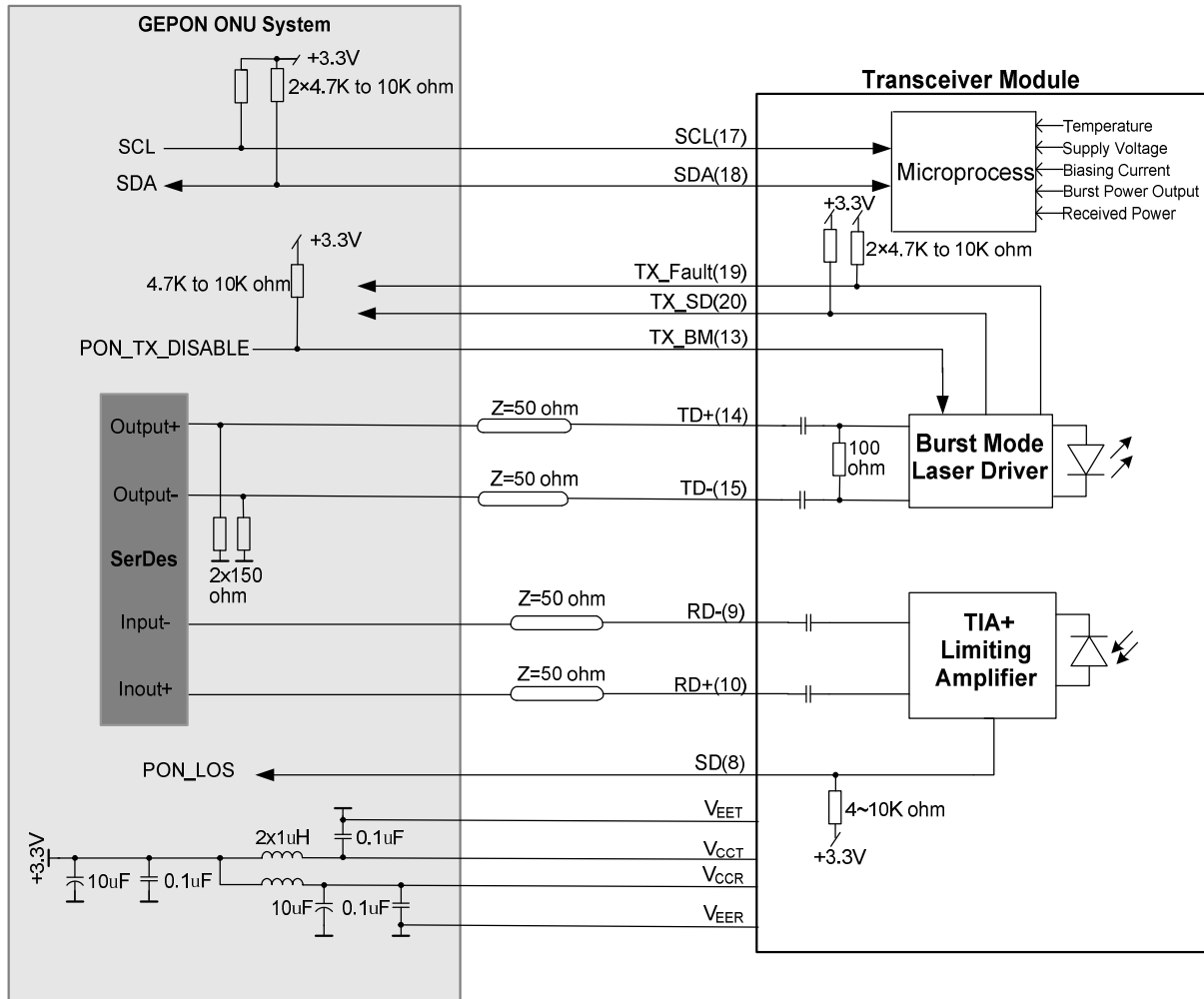

Figure 3 Typical Interface Circuit

PACKAGE OUTLINE

Unit:mm

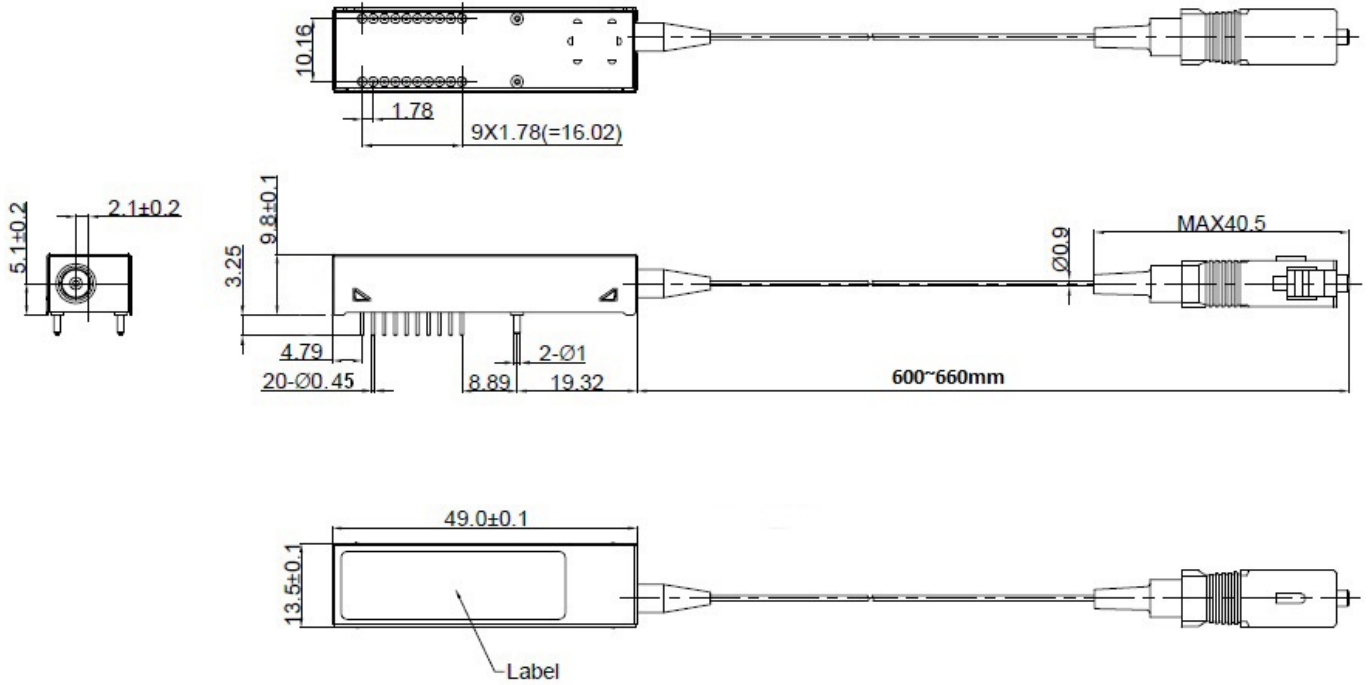
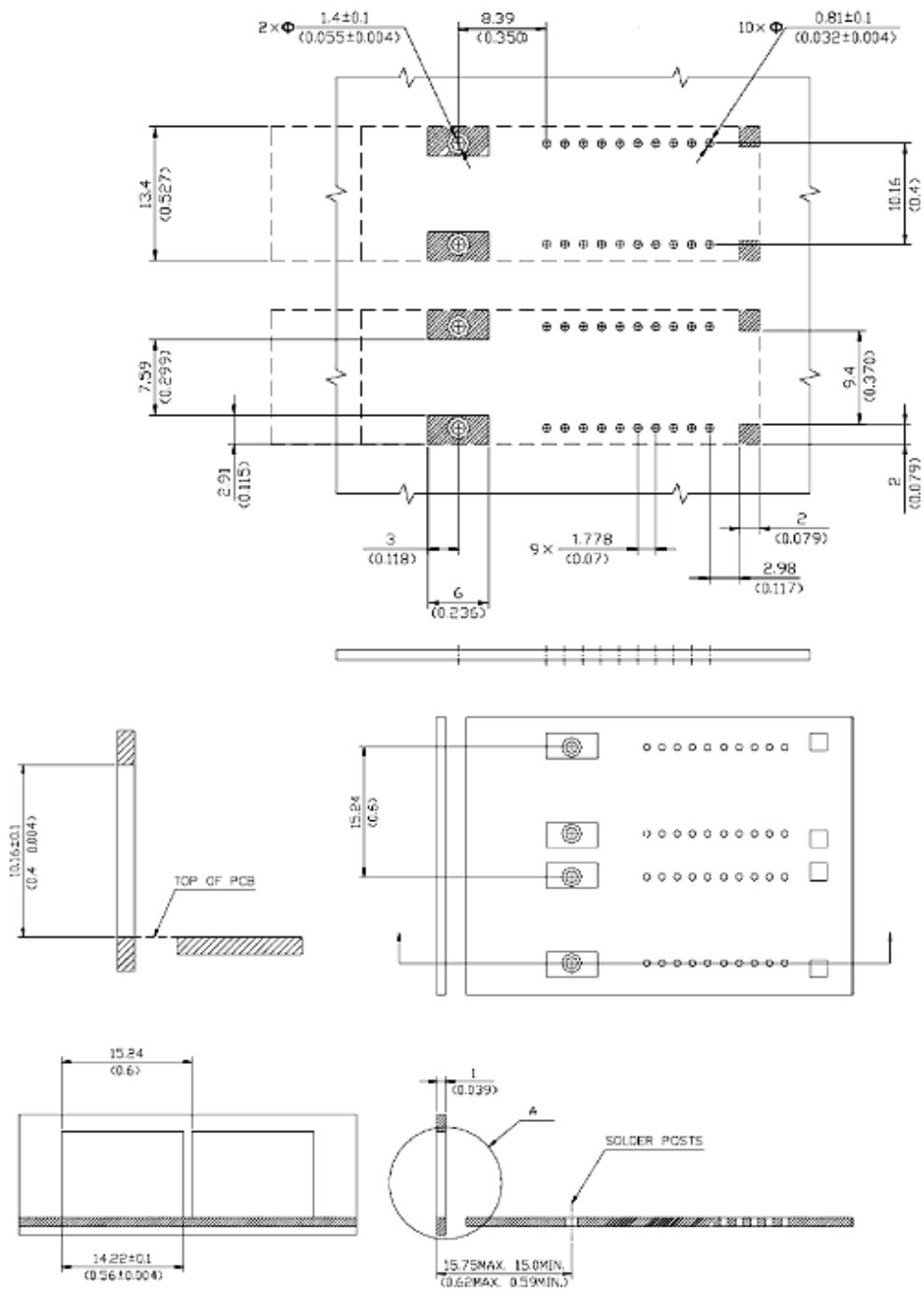

Figure 4 Package Outline

RECOMMENDED BOARD LAYOUT HOLE PATTERN AND PANEL MOUNTING



DIMENSIONS IN MILLIMETER (INCH)

NOTE1: THE HITCHED AREAS ARE KEEP OUT AREAS RESERVED FOR HOUSING STAND. AND NO METAL TRACKS OR GROUND CONNECTION IN KEEP OUT AREAS

NOTE2: SFF TRANSCEIVERS SHOULD KEEP 15.24mm MINIMUM SPACING

Figure 5 Recommended Board Layout Hole Pattern and Panel Mounting

EEPROM INFORMATION

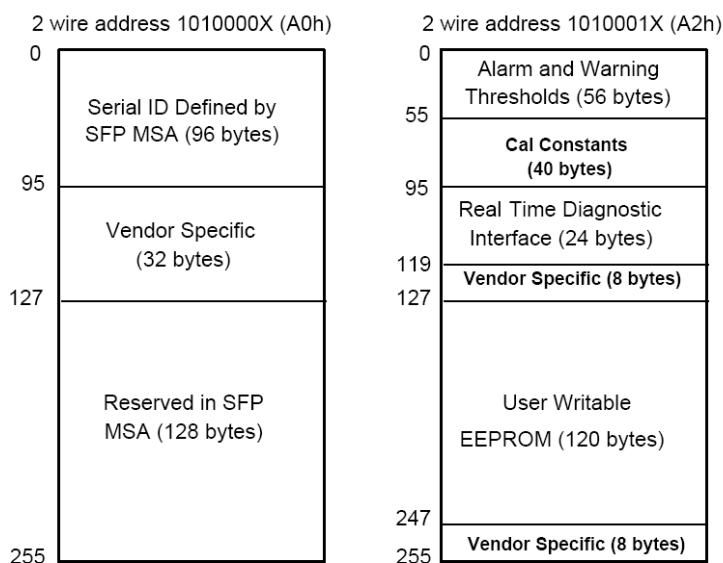

Figure 6 EEPROM Memory Map Specific Data Field Descriptions

DIGITAL DIAGNOSTIC MONITORING INTERFACE

Parameter	Range	Accuracy	Calibration	NOTES
Temperature	0 to 70°C	±3°C	Internal	LSB: 1/256C
Voltage	3.0 to 3.6V	±3%	Internal	LSB: 0.1mV
Bias Current	0 to 100mA	±10%	Internal	LSB: 2uA
TX Power	-1 to +5dBm	±3dB	Internal	LSB: 0.1uW
RX Power	-27 to -3dBm	±3dB	Internal	LSB: 0.1uW

ORDERING INFORMATION

PN	Temperature Rating	Unit
SOEB3466-FUGE(F)	0~ 70	°C

WARNINGS

- Y Handling Precautions: This device is susceptible to damage as a result of electrostatic discharge (ESD). A static free environment is highly recommended. Follow guidelines according to proper ESD procedures.
- Y Laser Safety: Radiation emitted by laser devices can be dangerous to human eyes. Avoid eye exposure to direct or indirect radiation.

LEGAL NOTES

- Y All information contained in this document is subject to change without notice, at Superxon’s sole and absolute discretion. Superxon warrants performance of its products to current specifications only in accordance with the company’s standard one-year warranty; however, specifications designated as “preliminary” are given to describe components only, and Superxon expressly disclaims any and all warranties for said products, including express, implied, and statutory warranties, warranties of merchantability, fitness for a particular purpose, and non-infringement of proprietary rights. Please refer to the company’s Terms and Conditions of Sale for further warranty information.
- Y Superxon assumes no liability for applications assistance, customer product design, software performance, or infringement of patents, services, or intellectual property described herein. No license, either express or implied, is granted under any patent right, copyright, or intellectual property right, and Superxon makes no representations or warranties that the product(s) described herein are free from patent, copyright, or intellectual property rights. Products described in this document are NOT intended for use in implantation or other life support applications where malfunction may result in injury or death to persons. Superxon customers using or selling products for use in such applications do so at their own risk and agree to fully defend and indemnify Superxon for any damages resulting from such use or sale.
- Y THE INFORMATION CONTAINED IN THIS DOCUMENT IS PROVIDED ON AN “AS IS” BASIS. Customer agrees that Superxon is not liable for any actual, consequential, exemplary, or other damages arising directly or indirectly from any use of the information contained in this document. Customer must contact Superxon to obtain the latest version of this publication to verify, before placing any order, that the information contained herein is current.
- Y Copyright © Sichuan Superxon Information Technology Co., Ltd.

All rights reserved.